

TR 232 S&L

OPERATING INSTRUCTIONS

Translation of the original instructions



NORTON
SAINT-GOBAIN®

clipper®





The undersigned manufacturer:

SAINT - GOBAIN ABRASIVES S.A.
190, BD J.F. KENNEDY
L- 4930 BASCHARAGE

Declares that this product:

Tile Saw (code): **TR 232 S 230 V (70184601110)**
TR 232 S 230 V UK (70184601111)
TR 232 S 115 V (70184601109)
TR 232 L 230 V (70184601103)
TR 232 L 230 V UK (70184601105)
TR 232 L 115 V (70184601104)

Is in conformity with the following Directives:

- **"MACHINES" 2006/42/CE**
- **"LOW VOLTAGE" 2014/35/UE**
- **"ÉLECTROMAGNÉTIQUE COMPATIBILITÉ" 2014/30/UE**
- **"NOISE" 2000/14/CE**

and European standard:

- **EN 12418 – Masonry and stone cutting-off machines – Safety**

Valid for machines as of serial number:

1601xxxxxxx

Storage site for the technical documents :

Saint-Gobain Abrasives 190, Bd. J. F. Kennedy 4930 BASCHARAGE, LUXEMBOURG

This declaration of conformity loses its validity when the product is converted or modified without agreement.

Bascharage, Luxembourg, 17.05.2019



François Chianese, executive officer.

TR 232 S&L

OPERATING INSTRUCTIONS

<u>1</u>	<u>BASIC SAFETY INSTRUCTIONS</u>	<u>6</u>
1.1	<i>Symbols</i>	6
1.2	<i>Machine plate</i>	7
1.3	<i>Safety instructions for particular operating phases</i>	7
<u>2</u>	<u>MACHINE DESCRIPTION</u>	<u>9</u>
2.1	<i>Short description</i>	9
2.2	<i>Purpose of use</i>	9
2.3	<i>Layout</i>	9
2.4	<i>Technical Data</i>	11
2.5	<i>Statement regarding the vibration emission</i>	12
2.6	<i>Statement regarding noise emission</i>	13
<u>3</u>	<u>ASSEMBLY AND COMMISSIONING</u>	<u>14</u>
3.1	<i>Assembly of the legs</i>	14
3.2	<i>Assembly of the handles</i>	14
3.3	<i>Cutting head</i>	15
3.4	<i>Assembly of the cooling system</i>	15
3.5	<i>Transport wheels</i>	16
3.6	<i>Longitudinal guide assembly</i>	16
3.7	<i>Side extension assembly</i>	17
3.8	<i>Installation of the handle for the cut in angle</i>	17
3.9	<i>Installation of the material holding system (TR 232 L only)</i>	19
3.10	<i>Tool assembly</i>	18
3.11	<i>Electrical connections</i>	19
3.12	<i>Water cooling system</i>	19
3.13	<i>Starting the machine</i>	19
<u>4</u>	<u>TRANSPORT AND STORING</u>	<u>20</u>
4.1	<i>Securing for transport</i>	20
4.2	<i>Storing of the machine</i>	20
<u>5</u>	<u>OPERATING THE MACHINE</u>	<u>22</u>
5.1	<i>Site of work</i>	22
5.2	<i>Cutting</i>	22
	<i>Important for cutting</i>	22
5.3	<i>Cutting with an angle</i>	22
<u>6</u>	<u>MAINTENANCE AND SERVICING</u>	<u>23</u>
<u>7</u>	<u>FAULTS: CAUSES AND CURES</u>	<u>24</u>
7.1	<i>Fault-finding procedures</i>	24
7.2	<i>Trouble-shooting guide</i>	24
7.3	<i>Circuit diagram</i>	25
7.4	<i>Customer service</i>	26

1 BASIC SAFETY INSTRUCTIONS

The TR 232 is exclusively designed for the cutting of tiles with NORTON diamond disks mainly on construction sites.

Uses other than the manufacturer's instructions shall be considered as contravening the regulations. The manufacturer shall not be held responsible for any resulting damage. Any risk shall be borne entirely by the user. Observing the operating instructions and compliance with inspection and servicing requirements shall also be considered as included under use in accordance with the regulations.

1.1 Symbols

Important warnings and pieces of advice are indicated on the machine using symbols. The following symbols are used on the machine:



Read operator's instructions



Ear protection must be worn



Hand protection must be worn



Eye protection shall be worn

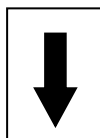

Rotation direction of the blade



Danger: risk of cut

1.2 Machine plate

Important data can be found on the following plate located on the machine:

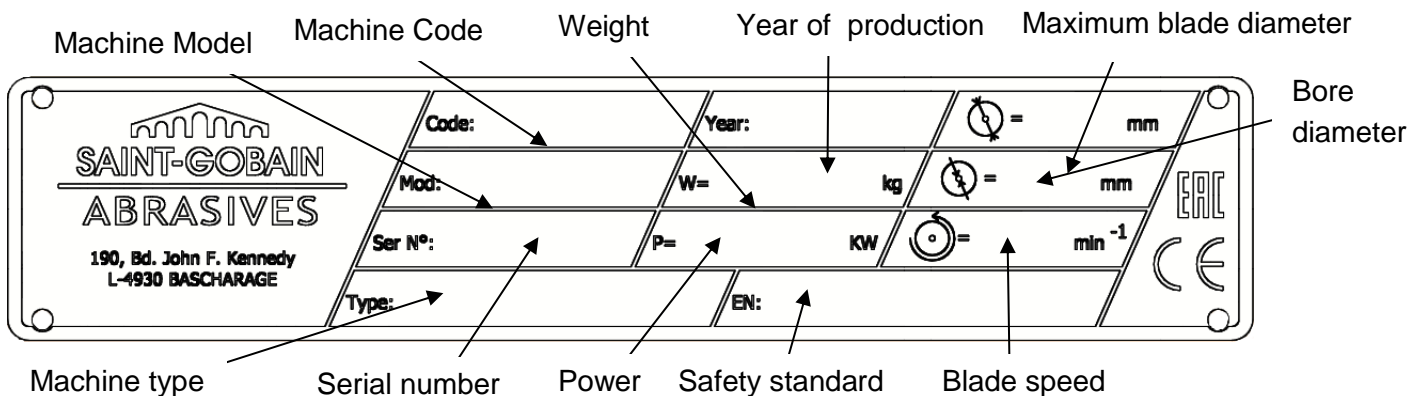

1.3 Safety instructions for particular operating phases

Before commencing work

- Before commencing work, make yourself familiar with the working environment at the place of use. The working environment includes: obstacles in the area of work and manoeuvre, the firmness of the floor, necessary protection at the site relating to public thoroughfares and the availability of help in the event of accidents.
- Site the machine on an even, firm and stable base!
- Check for correct mounting of the blade regularly.
- Immediately remove damaged or badly worn blades, as they endanger the operator whilst rotating.
- The material to be cut must be held securely in place on the table to allow no unexpected movement during cutting operation.
- Always cut with the blade guard in position.
- Only fit NORTON diamond blades with continuous rim to the machine! The use of other tools can damage the machine!
- Read the blades' specifications carefully to choose the correct tool for your application.
- Attention is drawn to the use of BS2092 safety goggles in conformity with specified Processes No.8 of the Protection of Eyes Regulation 1974, Regulation 2(2) Part 1. Also use the other safety equipment as mentioned in the symbols plus a dust mask when dry cutting is applied.

Electrical powered machine

- Always turn off the TR 232 and separate it from the main source of electricity before any work on the machine is done.
- Make all electrical connections securely to eliminate contact of live wires with spray water or dampness
- When TR 232 is used with water, it is IMPERATIVE that you earth the machine properly. Let a qualified electrician check in case of doubt.
- Press the red button (0) on the switch to stop the machine in case of emergency.
- In the event of the TR 232 breaking down or stopping for no apparent reason, switch off the main electricity supply. Only a qualified electrician is allowed to investigate the trouble and remedy the fault.

2 MACHINE DESCRIPTION

Any modification, which could lead to a change in the original characteristics of the machine, may be done only by Saint-Gobain Abrasives who shall confirm that the machine is still in conformity with the safety regulations.

2.1 Short description

The TR 232 Saw is designed for durability and high performance for onsite wet cutting operations of a wide range of tiles.

As with all other NORTON CLIPPER products, the operator will immediately appreciate the attention given to detail and quality of materials used in construction. The machine and its component parts are assembled to high standards assuring long life and minimum maintenance.

2.2 Purpose of use

The machine is designed for wet cutting of a large range of building and refractory materials, or tiles. **It is not designed for cutting wood, metals or other materials.**

2.3 Layout

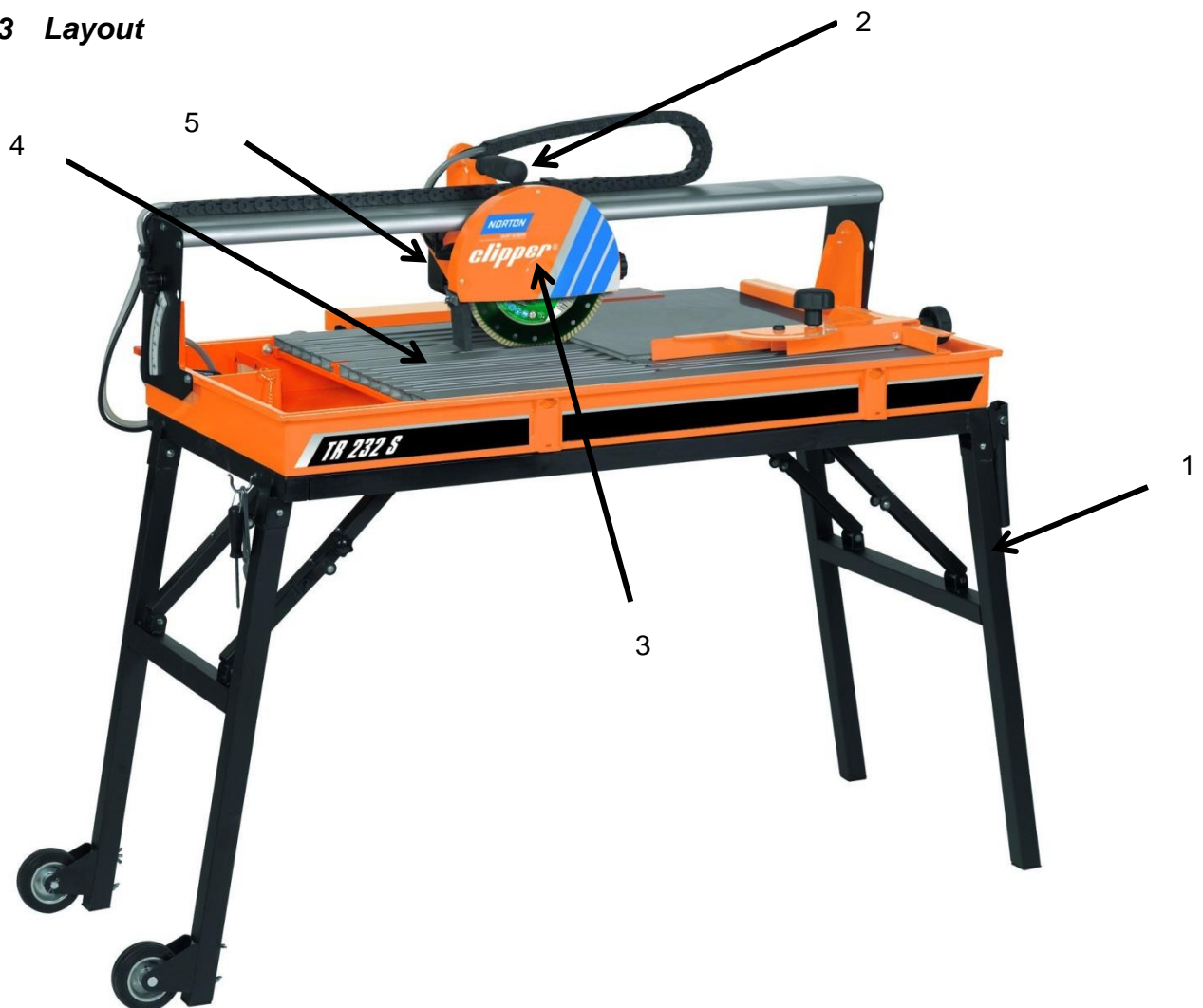

Frame (1)

The frame is made of aluminium and steel to ensure robustness and durability. The folding stand with 4 legs ensures stability while cutting.

Cutting head (2)

Aluminium console guided with precision. This console supports the electric motor, the guides and the blade guard. The head can be tilted to cut with an angle from 0 to 45°.

Blade guard (3)

The blade guard assembly with a 230mm-diameter blade capacity is completely closed, but the outside cover can be disassembled to access the blade. It offers maximum operator protection and increased visibility of the work piece. The tightening of the fixing flange is done by a hexagonal head screw (left-hand thread).

Water cooling (4)

The coolant system comprises:

- A submersible mechanical water pump.
- Plastic suction pipe delivering the water from the water pan to the cutting head.
- A removable large capacity plastic water pan located under the cutting table to reduce water loss.
- A nozzle of watering located on the casing of the disc for a good distribution of water on the disc.

Electric Motor (5)

One phase 1,1 kW motor. The switch with the red and green buttons is used to start and turn off the engine. The red button is also an emergency stop.

2.4 Technical Data

	TR 232 L		TR 232 S	
Item number	70184601103	70184601105 (UK)	70184601110	70184601111 (UK)
Electric motor	1,1 kW			
Supply voltage	230V			
Rating protection	230V, 50Hz			
Blade diameter	IP54			
Bore	230 mm			
Rotation speed of the blade	25,4 mm			
Maximum cutting height	2950 min ⁻¹			
	0°			
	45°			
Maximum material weight on table	15 mm			
	10 mm			
	15 kg			
Cutting length	1200		860	
Flange diameter	90			
Sound pressure level	71 dB (A) (selon ISO EN 11201)			
Sound energy level	79 dB (A) (selon ISO EN 3744)			
Table dimensions (LxW)	1200X565 mm		860x565mm	
Machine dimensions (LxWxH)	1860x600x1175 mm		1560x600x1175 mm	
Weights :				
Machine cpl.	72 kg		61 kg	
Ready for use (with water)	94 kg		77 kg	

2.5 Statement regarding the vibration emission

Declared value of vibration emission following **EN 12096**.

Machine Model / code	Measured value of vibration emission at m/s ²	Uncertainty K m/s ²	Tool used Model / code
TR232 S: 70184601109 70184601110 70184601111 TR232 L: 70184601103 70184601104 70184601105	<2.5	0.5	Extreme ceram turbo/Clipper Super Gres XT

- The vibration value is lower and does not exceed 2.5 m /s².
- Values determined using the procedure described in the standard **EN 12418**.
- The measurements are made with new machines. Actual values may vary with site conditions, in terms of:
 - Materials worked
 - Wear Machine
 - Lack of maintenance
 - Inappropriate tool for application
 - Tool in poor condition
 - Unskilled operator
 - Etc...
- The exposure time to vibration is based on the performance of work (related to the adequacy Machine / Tool / worked material / operator)

When evaluating risks due to hand-arm vibration, you need to take into account effective usage at rated power of machine during a full day of work; quite often you will realise that effective utilisation time represents around 50% of overall duration of work. You have to consider, of course, breaks, water feeding, preparation of work, time to move the machine, disk mounting...

2.6 Statement regarding noise emission

Declared value of noise emission following **EN ISO 11201** and **NF EN ISO 3744**.

Machine Model / code	Sound Pressure level L_{Peq} EN ISO 11201	Uncertainty K (Sound Pressure level L_{Peq} EN ISO 11201)	Sound power level L_{Weq} NF EN ISO 3744	Uncertainty K (Sound power level L_{Weq} NF EN ISO 3744)
TR232 S: 70184601109 70184601110 70184601111 TR232 L: 70184601103 70184601104 70184601105	79 dB(A)	2.5 dB(A)	71 dB(A)	4 dB(A)

- Values determined using the procedure described in the standard **EN 12418**.
- The measurements are made with new machines. Actual values may vary with site conditions, in terms of:
 - Wear Machine
 - Lack of maintenance
 - Inappropriate tool for application
 - Tool in poor condition
 - Unskilled operator
 - Etc...
- Measured values relate to an operator in normal use, as described in the manual position.

3 ASSEMBLY AND COMMISSIONING

The TR 232 is delivered fully equipped. It is ready for operation after assembly of the diamond blade and after connection to the appropriate power supply.

3.1 Assembly of the legs

- Lift up one side of the saw and unfold the legs without wheels. Lift up the other side of the saw and unfold the legs with the wheels.



- Encase the arm of blocking in the pin and tighten the button knurled to prevent that the feet are not folded up.



3.2 Assembly of the handles

- In order to seize the machine more easily, fix the two handles on the side of the machine using the screws and nuts.



3.3 Cutting head

- Fix the handle of the cutting head using two screws.

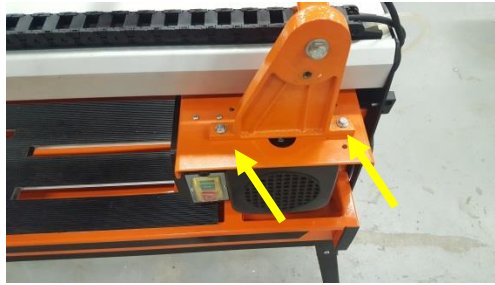

- To be able to use your machine, you must release the head of cut. For that unscrew the knurled button which maintains the head on the right amount during transport.

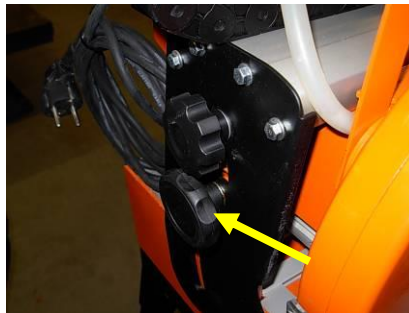

3.4 Assembly of the cooling system

- Fix the cable containing the water pipe along the rail of the head of cut.



- Mount the pump in the vat to water and the drain plug



3.5 *Transport wheels*

- To be able to move your machine easily, assemble the wheels to the bottom of the feet located on the side opposite of the handles, using the screws butterflies.



3.6 *Longitudinal guide assembly*



Insert 2 threaded and pinned shafts

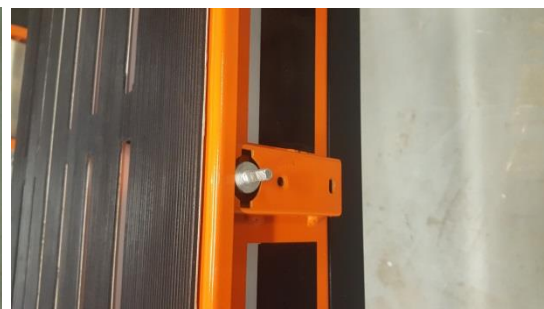

Rotate both shafts by 90°

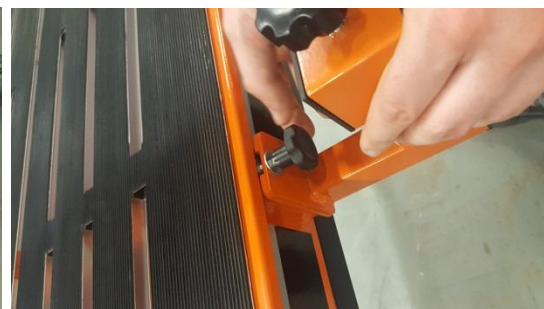
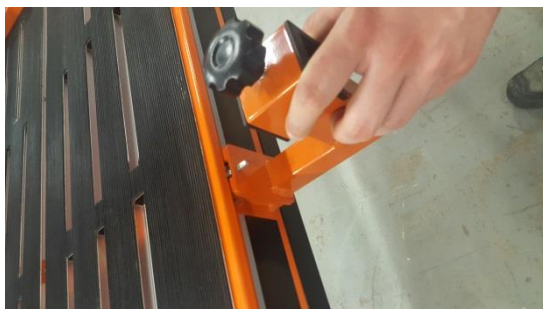

Insert both guide supports and lock them with knobs



Insert the guide in both supports



then lock the knobs

3.7 Side extension assembly



Insert both pinned shafts



Rotate both shafts by 90° to lock side extension

3.8 Installation of the handle for the cut in angle



3.9 Installation of the material holding system (TR 232 L only)

- In order to ensure an optimal material holding during the cut, use the grasshoppers envisaged for this purpose.



3.10 Tool assembly

Only NORTON blades with a diameter of 230 mm can be used with the TR 232.

All tools used must be selected with regard to their maximum permitted cutting speed for the machine's maximum permitted rotation speed. Before mounting a new blade into the machine, switch off the machine and isolate it from the main source of electricity.

To assemble a new blade, follow these steps:

- Loosen the three screws holding the outer cover of the blade guard using the crosshead screwdriver supplied with TR 232, and remove it.
- Loosen the hexagonal nut (left threaded) on the blade shaft using the 18 mm wrench supplied with TR 232, which holds the removable outer flange.
- Remove the outer flange.
- Clean the flanges and blade shaft and inspect for wear.
- Mount the blade on the shaft ensuring that direction of rotation is correct (check with the arrow on the blade guard). Wrong direction of rotation blunts the blade quickly.
- **WARNING:** The blade bore must correspond exactly to the blade shaft. Cracked or damaged bore is dangerous for the operator and for the machine.
- Put outer blade flange back in place.
- Tighten hexagonal nut using 18 mm wrench.
- Put the outer cover of the blade guard back in place and tighten the three holding screws with the crosshead screwdriver.

WARNING: the blade bore must correspond exactly to the diameter of the blade shaft. Cracked or damaged bore is dangerous for the operator and for the machine.

3.11 Electrical connections

Check that:

- The voltage/phase supply corresponds to the information indicated on the motor plate.
- Available power supply must have ground connection in conformity with safety regulations.
- The connecting cables should have at least a 2.5mm²-section per phase.

3.12 Water cooling system

- Fill the TR 232 with clean water up to 1cm under the top edge of the water tray. The pump will switch on together with motor.
- Ensure that water is delivered adequately to the blade, as insufficient water supply may result in premature failure of the diamond blade.
- The water pump must never run without water. Always make sure that there is enough water in the pan and refill if necessary.
- In case of frost, empty the water cooling system from its water.

3.13 Starting the machine

Connect your machine to the electric source. To start the machine, press the green button on the switch. To stop the machine, press the red button. This one is also an emergency stop key.

4 TRANSPORT AND STORING

Please follow the following instructions to transport and store the TR232 in a safe way.

4.1 Securing for transport

Before transporting the machine, always remove the blade and empty the water pan. Secure the cutting head on the rail by using the knob. Store the longitudinal cutting guide and the side extension in the pan. Fold the legs.

WARNING: this machine is not suited to be lifted with a crane.

- Lock cutting head



- Tighten angular cutting guide



- Store the longitudinal cutting guide and the side extension:
 - Dismount the table
 - Store the elements in the pan, then put the table back in place



4.2 Storing of the machine

If the machine is not going to be used for a long period, please take the following measures:

- Completely clean the machine
- Empty the water system
- Take the water pump out of the water tray, and clean it thoroughly.

The storage site must be clean, dry and at a constant temperature.

5 OPERATING THE MACHINE

You will find in this chapter of the advices to use the machine in a safe way.

5.1 *Site of work*

5.1.1 Siting the machine

- Remove from the site anything, which might hinder the working procedure!
- Make sure the site is sufficiently well lit!
- Observe manufacturer's conditions for connecting to power supplies!
- Place electric cables in such a way that damage is excluded!
- Make sure you have a continual adequate view of the working area so you can intervene in the working process at any time!
- Keep other staff out of the area, so you can work securely.

5.1.2 Space required for operation and maintenance

Leave 2 m in front of the machine and 1.5 m around it for usage and maintenance of the TR 232.

5.2 *Cutting*

To use the TR 232 correctly, you must face it with one hand on the cutting head, and the other on the material to be cut to maintain it against the material stops. Always keep your hands away from the moving blade.

The long longitudinal cutting guide and the side extension can help you to achieve high accuracy cuts, even with large materials.

Important for cutting

- Only materials with max. dimensions of 1200x800x15mm and max. weight of 15kg can be cut with the TR 232.
- Before commencing work make sure tools are firmly seated!
- Select the right tools as recommended by the manufacturer depending on the material to be worked, the working procedure (wet cut) to be carried out and the required efficiency.
- Make sure the water pan contains enough water.
- Use only set with diamonds discs NORTON CLIPPER. The use of other tools can involve the damage of the machine.
- Do not force on the engine. This machine is not designed for a continuous use.

5.3 *Cutting with an angle*

You can cut from 0° to 45° by tilting the head rail. For this purpose:

- Loosen the two knobs maintaining the head rail to tilt the head to the desired angle.
- Retighten the two knobs.
- According to the angle of cut wished, the position of the handle of the head of cut can be modified to improve comfort of the user at the time of the cut.

6 MAINTENANCE AND SERVICING

To ensure a long-term quality from the cutting with the TR 232, please follow the maintenance plan below:

		Before starting work	During tool change	End of each day or more often if required	During a failure	After a damage
Whole machine	Visual control (general aspect, water tightness)					
	Clean					
Flange and blade fixing devices	Clean					
Motor cooling fans	Clean					
Water pan	Clean					
Motor housing	Clean					
Reachable nuts and screws	Tighten up					
Water pump	Clean					

Maintenance of the machine

Always perform the maintenance of the machine with the machine isolated from the electrical supply.

Lubrication

The TR 232 uses life-lubricated bearings. Therefore, you don't need to lubricate the machine at all.

Cleaning of the machine

Your machine will last longer if you clean it thoroughly after each day of work, especially water pump, water pan, motor and blade flanges.

7 FAULTS: CAUSES AND CURES

7.1 *Fault-finding procedures*

Should any fault occur during the use of the machine, turn it off, and isolate it from the electrical supply. Any works dealing with the electrical system or supply of the machine can only be carried out by a qualified electrician.

7.2 *Trouble-shooting guide*

Trouble	Possible source	Resolution
Motor is not running	No electricity	Check the electrical supply (fuse for example)
	Connection cable section too small	Change connection cable
	Defective connection cable	Change connection cable
	Defective switch	CAUTION : can only be solved by qualified electrician
	Defective motor	Change motor or contact motor manufacturer
Motor stops during the cutting, but can be restarted after a short period (overload protection)	Cutting feed speed too quick	Cut slowly
	Blade is blunt or glazed	Sharpen the blade in calcareous stone
	Defective blade	Change blade
	Wrong blade specification for the application	Change blade
No water on the blade	Not enough water in the pan	Refill the water pan
	Water supply system is blocked up	Clean water supply system
	Water pump is not working	Change the pump

7.3 Circuit diagram

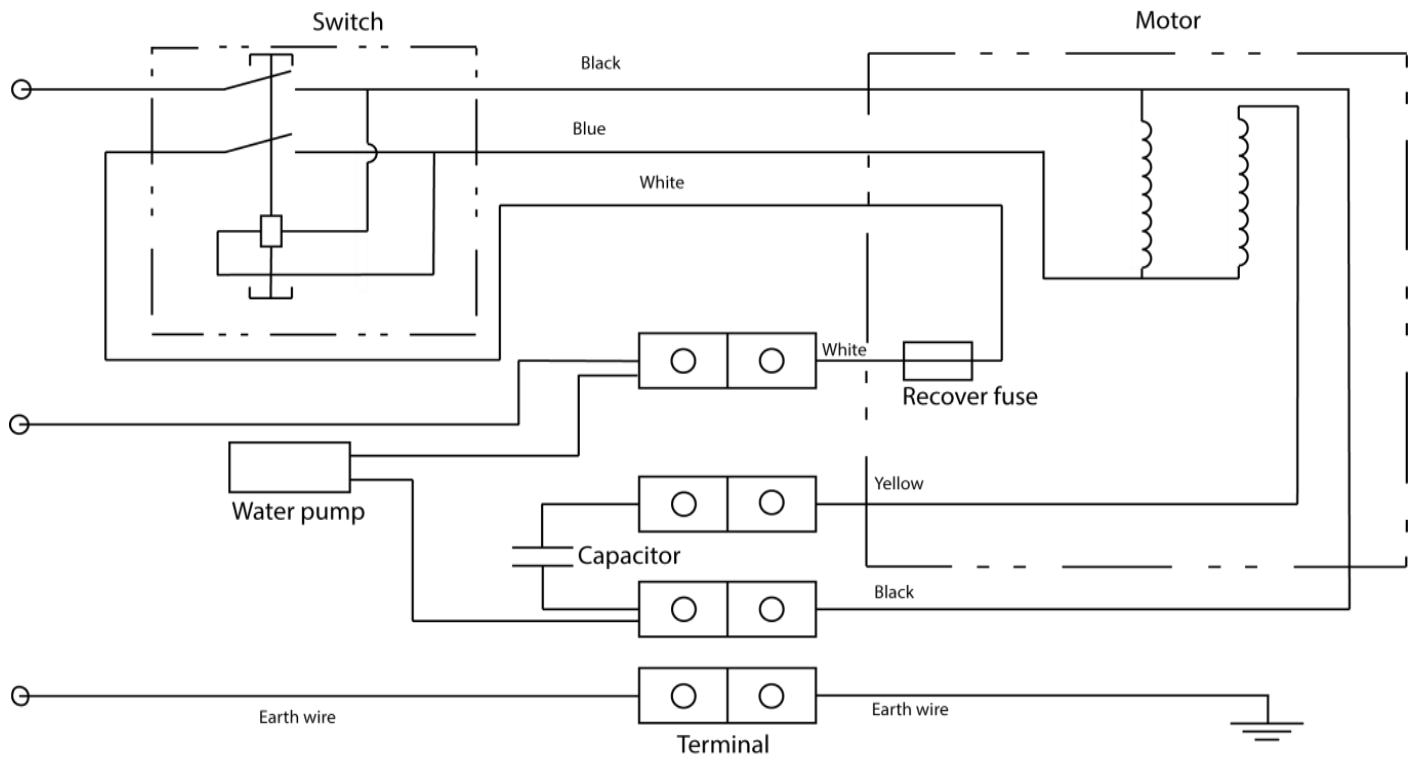

7.4 Customer service

When ordering spare parts, please mention:

- The serial number (7 digits).
- The code of the part.
- The exact denomination.
- The number of parts required.
- The delivery address.
- Please indicate clearly the means of transportation required such as "express" or "by air". Without specific instructions, we will forward the parts through the means which seem appropriate to us --- but which is not always the quickest way.

Clear instructions will avoid problems and faulty deliveries.

If not sure, please send us the defective part.

In the case of a warranty claim, the part must always be returned for evaluation.

Spare parts for the motor can be ordered with the manufacturer of the motor or with their dealer, which is often quicker and cheaper.

This machine has been manufactured for Saint-Gobain Abrasives S.A.
190, Bd J.F.Kennedy
L- 4930 BASCHARAGE
Grand-Duché de Luxembourg.
Tel. : 00352-50 401-1
Fax : 00352- 50 16 33
www.construction.norton.eu
e-mail:sales.nlx@saint-gobain.com

In order to consult the spare parts lists, we invite you to visit the after-sales website of Norton Clipper by using the following address:

<https://spareparts.nortonabrasives.com>

For a quick access, you can also use the QR Code shown below using your mobile phone:



This electronic catalogue provides exploded views and spare parts lists for different machines designed by Norton Clipper so you can find references you need.

Guarantee can be claimed and technical support obtained from your local distributor where machines, spare parts and consumables can be ordered as well:

SAINT-GOBAIN ABRASIVES
INDUSTRIEWEG 21
9420 ERPE-MERE
BELGIUM
TEL: +32(0) 2 267 21 00

SAINT-GOBAIN ABRASIVES, S.R.O.
POČERNICKÁ 272/96, MALEŠICE
108 00 PRAHA 10
CZECH REPUBLIC
TEL: +420 255 719 326
FAX: +420 255 719 321

SAINT-GOBAIN ABRASIVES A/S
DYBENDALSVEJENGET 2,
DK-2630 TAASTRUP
DENMARK
TEL: +45 4675 5244

PO BOX 643706
FORTUNE TOWER OFFICE 2106
JLT BLOCK C
(NEXT TO METRO STATION)
JUMEIRA LAKE TOWER, DUBAI
UNITED ARAB EMIRATES
TEL: +971 4 431 5154
FAX: +971 4 431 5434

SAINT-GOBAIN ABRASIFS
RUE DE L'AMBASSADEUR - B.P.8
78 702 CONFLANS CEDEX
FRANCE
TEL: +33 (0)1 34 90 40 00
FAX: +33 (0)1 39 19 89 56

SAINT-GOBAIN ABRASIVES GMBH
BIRKENSTRASSE 45-49
D-50389 WESSELING
GERMANY
TEL: +49 (0) 2236 703-1
+49 (0) 2236 8996-0
+49 (0) 2236 8911-0
FAX: +49 (0) 2236 703-367
+49 (0) 2236 8996-10
+49 (0) 2236 8911-30

FÜR DEN FACHHANDEL
ÖSTERREICH
TEL: +43 (00) 662 430 076

SAINT-GOBAIN ABRASIVES KFT.
1225 BUDAPEST
BÁNYALÉG U. 60/B.
HUNGARY
TEL: +36 1 371 22 50
FAX: +36 1 371 22 55

SAINT-GOBAIN ABRASIVI S.P.A
VIA PER CESANO BOSCONI 4
I-20094 CORSICO MILANO
ITALY
TEL: +39 02 44 851
FAX: +39 02 44 78 266

SAINT-GOBAIN ABRASIVES S.A.
190 RUE J.F. KENNEDY
L-4930 BASCHARAGE
GRAND DUCHE DE LUXEMBOURG
TEL: +352 50 401 1
FAX: +331 83 717 792
NO. VERT (FRANCE): 0800 906 903

SAINT-GOBAIN ABRASIFS, S.A.
2 ALLÉE DES FIGUIERS
AIN SEBAÂ - CASABLANCA
MOROCCO
TEL: +212 5 22 66 57 31
FAX: +212 5 22 35 09 65

SAINT-GOBAIN ABRASIVES BV
GROENLOSEWEG 28
7151 HW EIBERGEN
P.O. BOX 10
7150 AA EIBERGEN
THE NETHERLANDS
TEL: +31 545 466466
FAX: +31 545 474605

SAINT-GOBAIN ABRASIVES AS
POSTBOKS 11, ALNABRU,
0614 OSLO
BROBEKKVEIEN 84,
0582 OSLO
NORWAY
TEL: +47 63 87 06 00
FAX: +47 63 87 06 01

SAINT-GOBAIN HPM POLSKA SP. Z O.O.
UL. NORTON 1, 62-600 KOŁO
62-600 KOŁO
POLAND
TEL: +48 63 26 17 100
FAX: +48 63 27 20 401

SAINT-GOBAIN ABRASIVOS, L. DA
ZONA INDUSTRIAL DA MAIA
I-SECTOR VIII, NO. 122
APARTADO 6050
4476 - 908 MAIA
PORTUGAL
TEL: +351 229 437 940
FAX: +351 229 437 949

SAINT-GOBAIN GLASS
BUSINESS UNIT ABRASIVI
PUNCT DE LUCRU: LOC.VETIS,JUD.
SATU MARE 447355
STR. CAREIULUI 11
PARC INDUSTRIAL RENOVATIO
ROMANIA
TEL: +40 261 839 709
FAX: +40 261 839 710

SG HPM RUS
58, F. ENGELS STR.
STROENIE 2
105082 MOSCOW
RUSSIA
TEL: +74 955 408 355
FAX: +74 959 373 224

SAINT-GOBAIN
ABRASIVES (PTY) LTD
2 MONTEER ROAD
ISANDO 1600
P.O. BOX 67
SOUTH AFRICA
TEL: +27 11 961 2000
FAX: +27 11 961 2184/5

SAINT-GOBAIN ABRASIVOS, S.A.
CTRA. DE GUIPÚZCOA, KM. 7,5
E-31195 BERRIOPLANO (NAVARRA)
SPAIN
TEL: +34 948 306 000
FAX: +34 948 306 042

SAINT GOBAIN ABRASIVES AB
GÅRDSFOGDEVÄGEN 18A
168 66 BROMMA • SVERIGE
SWEDEN
TEL: +46 8 580 881 00
FAX: +46 8 580 881 30

SAINT-GOBAIN INOVATIF MALZEMELER
VE ASINDIRICI SAN. TIC. AS.
ALTAYÇEŞME MAH. ÇAMLI SOK. NO:21
ESAS OFISPARK KAT:9 34843
MALTEPE, İSTANBUL • TURKEY
TEL: 0090-216-217 12 50
FAX: 0090-216-442 40 74

SAINT-GOBAIN ABRASIVES LTD.
DOXEY RD
STAFFORD
ST16 1EA
UNITED KINGDOM
TEL: +44 1785 222 000
FAX: +44 1785 213 487



Saint-Gobain Abrasifs
190 Rue J.F. Kennedy
L-4930 Bascharage
Grand Duche de Luxembourg
Tel: +352 50 401 1
Fax: +352 50 16 33
no. vert (France) 0800 906 903

www.nortonabrasives.com/